

Rotary actuator for butterfly valves

- Nominal torque 2000 Nm
- Nominal voltage AC 230 V
- Control Open-close, 3-point
- with 2 integrated auxiliary switches

Technical data

Electrical data	Nominal voltage	AC 230 V
	Nominal voltage frequency	50/60 Hz
	Nominal voltage range	AC 207...253 V
	Power consumption in operation	180 W
	Power consumption in operation note	incl. heating
	Power consumption in rest position	4.8 W
	Power consumption for wire sizing	368 VA
	Current consumption	1.6 A
	Auxiliary switch	2 x SPDT, 1 x 3° / 1 x 87°
	Switching capacity auxiliary switch	1 mA...5 (3 inductive) A, DC 5 V...AC 250 V
	Connection supply / control	Terminals 2.5 mm ² (Wire 2 x 1.5 mm ² or 1 x 2.5 mm ²)
	Parallel operation	No
Functional data	Torque motor	2000 Nm
	Manual override	Temporary with handwheel (non-rotating)
	Angle of rotation	90°
	Angle of rotation note	Internal limit switch, not adjustable
	Running time motor	70 s
	Duty cycle	30 % (= active time 70 s / operating time 233 s)
	Sound power level motor	70 dB(A)
	Position indication	Mechanically (integrated)
Safety	Protection class IEC/EN	I Protective earth
	Protection class auxiliary switch IEC/EN	I Protective earth
	Degree of protection IEC/EN	IP67
	EMC	CE according to 2004/108/EC
	Low voltage directive	CE according to 2006/95/EC
	Mode of operation	Type 1
	Control pollution degree	4
	Ambient temperature	-30...65°C
	Non-operating temperature	-30...80°C
	Ambient humidity	95% r.h., non-condensing
Maintenance	Maintenance-free	
Mechanical data	Connection flange	F16
Weight	Weight approx.	72 kg
Materials	Housing material	Aluminium pressure casting

Safety notes

- This device has been designed for use in stationary heating, ventilation and air conditioning systems and is not allowed to be used outside the specified field of application, especially in aircraft or in any other airborne means of transport.
- Caution: Power supply voltage!
- Only authorised specialists may carry out installation. All applicable legal or institutional installation regulations must be complied during installation.
- The device does not contain any parts that can be replaced or repaired by the user.

Safety notes

- The device contains electrical and electronic components and is not allowed to be disposed of as household refuse. All locally valid regulations and requirements must be observed.

Product features

Simple direct mounting	Simple direct mounting on the butterfly valve. The mounting orientation in relation to the butterfly valve can be selected in 90° (angle) increments.
Manual override	The butterfly valve can be closed (turn clockwise) and opened (turn anticlockwise) with the handwheel. The handwheel does not move while the motor is running. The butterfly valve remains in its position as long as no voltage is applied.
Internal heating	An internal heater prevents condensation buildup.
High functional reliability	Mechanical end stops limit the actuator to -2° and 92°. The internal limit switches interrupt the voltage supply to the motor. In addition, a motor thermostat provides overload protection and interrupts the voltage supply if the actuator is used outside of the specified temperatures.
Combination valve/actuator	Refer to the valve documentation for suitable valves, their permitted medium temperatures and closing pressures.
Signalling	The integrated auxiliary switches are equipped with a gold/silver coating that permits integration both in circuits with low currents (mA range) and in ones with larger-sized currents (A range) in accordance with the specifications in the data sheet. It should be noted with this application however that the contacts can no longer be used in the milliampere range after larger currents have been applied to them, even if this has taken place only once.

Electrical installation



Notes

- Caution: Power supply voltage!

Wiring diagrams

AC 230 V, open-close, 3-point

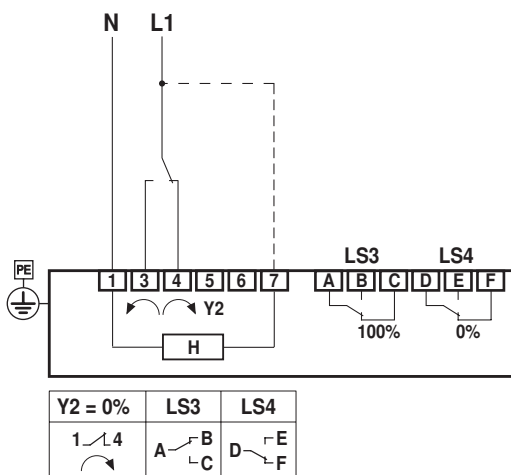

H: Internal heating (no need to connect internal heating for indoor applications with constant temperature conditions)
 LS3: Auxiliary switch 100% (butterfly valve open)
 LS4: Auxiliary switch 0% (butterfly valve closed)

Settings



Notes

- Limit switches TC1/TC2 and angle of rotation limitation are provided with sealing varnish and may not be adjusted.

Setting cam

The setting cams for limit and auxiliary switches can be accessed by removing the housing cover.

Optionally, auxiliary switches LS4 / LS3 can be connected for signalling.

Limit switches LS2 / LS1 interrupt the voltage to the motor and are controlled by setting cams TC..

The setting cams turn with the stem. The butterfly valve closes when the stem is turning clockwise (cw) and opens when the stem is turning counterclockwise (ccw).

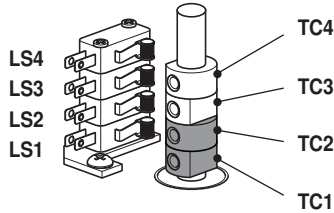

TC1/TC2 with sealing varnish: limit switches are secured against adjustment

Settings of setting cams TC..

- TC4 for auxiliary switch position closed (factory setting 3°).
- TC3 for auxiliary switch position open (factory setting 87°).
- TC2 for limit switch closed (0°).
- TC1 for limit switch open (90°).

Adjusting setting cams

- 1) Use a 2.5 mm Allen key to unscrew the corresponding setting cams TC..
- 2) Turn the setting cam using the Allen key
- 3) Set as shown in the illustration below
- 4) Use the Allen key to tighten the corresponding setting cams

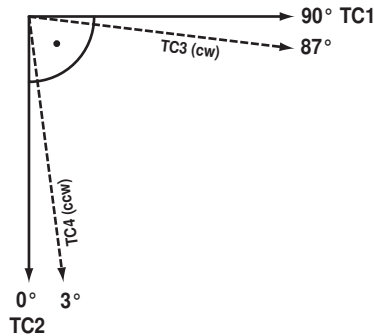

TC1: OPEN
TC2: CLOSED
TC3: Present position
TC4: Desired position

Mechanical angle of rotation limitation

The mechanical angle of rotation (3) is set at the factory to -2° and 92° and cannot be changed.

The handwheel is rotated by means of a worm gear in a planetary gear unit. The gearing is stopped mechanically by means of two setscrews (3).

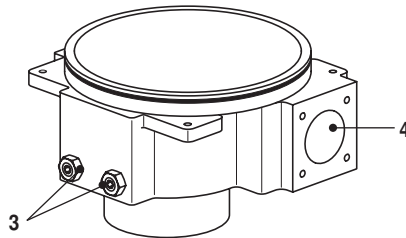

3: Angle of rotation limitation with sealing varnish: Must not be adjusted
4: Connection handwheel

Relationship between mechanical angle of rotation limitation, limit and auxiliary switches

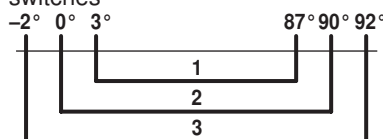

1: Auxiliary switch adjustable TC3 / TC4
2: Limit switch fix adjusted TC1 / TC2
3: Mechanical angle of rotation fix adjusted

Dimensions [mm]

Dimensional drawings

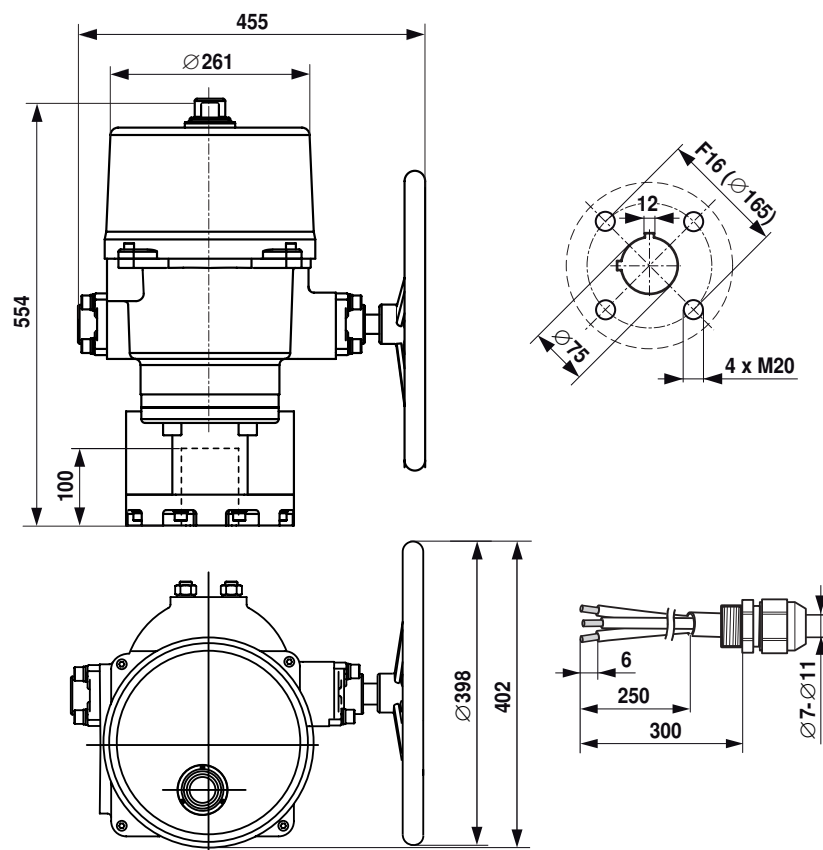

Further documentation

- Data sheets for butterfly valves
- Installation instructions for actuators and/or butterfly valves
- Notes for project planning for butterfly valves